

LOUDSPEAKER ENCLOSURE DESIGN

By E. J. JORDAN*

2.—A Cabinet of Reduced Size With Better Low-frequency Performance

IN the first part of this article the features of performance and design of the principal methods of mounting a loudspeaker were reviewed. These may be briefly summarized in order of merit, as follows.

Full Horn.—Acoustically this is the ideal method of loudspeaker mounting. It provides excellent air loading on the cone, is devoid of self-resonance and possesses a high radiation efficiency down to any desired frequency, being limited only by the horn dimensions. The disadvantage of the horn is the very great size required for effective operation down to very low frequencies.

Absorbing Labyrinth.—This again presents excellent resonance-free air loading on the loudspeaker cone, and in this respect is comparable to the horn. It is effective down to any desired frequency, being limited, like the horn, by its dimensions. Unlike the horn, however, the disadvantage of this system is the falling efficiency at low frequencies due to the approach to constant-velocity conditions, although this may be partially compensated for in the amplifier. A labyrinth capable of good absorption down to very low frequencies is still rather big.

Reflex Enclosure.—The advantage of the reflex cabinet is that excellent damping is applied to the loudspeaker cone at its resonance where it is most required. A further point in its favour is that it is relatively simple to construct. The bass response from a reflex enclosure will have an efficiency somewhat higher than that from a labyrinth, and for a given bass extension, will be smaller, although it still makes a rather dominating piece of furniture in the drawing-room. The response will not be so smooth as for a labyrinth due principally to the upper of the two resonances common to this type of mounting. If very much bass boost is applied the reflex enclosure will tend to sound boomy, also port radiation at the lower of the two resonances will tend to cancel that from the cone.

Wall Mounting or Large Flat Baffle.—This type of loudspeaker mounting presents a lower impedance to the rear of the loudspeaker cone than any other, therefore with the exception of horn loading, this system has the highest efficiency among direct

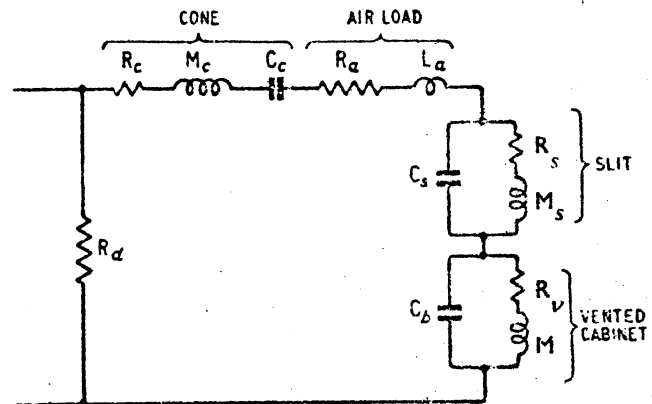

Fig. 8. Electrical analogue of loudspeaker-cabinet system incorporating an additional restricted aperture in front of the cone. M_s and R_s are the mass and resistance associated with the slit and C_s is the compliance formed between the cone and the inside face of the orifice.

radiators. The low acoustic damping applied to the cone, however, makes necessary the use of a loudspeaker unit having a high degree of electro-magnetic damping, if excessive cone velocity is to be avoided, in which case the relative efficiency of the system at low frequencies is lost and its performance will be similar to that of a labyrinth.

Recent Trends.—It has for years been the ambition of designers to produce a loudspeaker system having the performance of a horn and the dimensions of an orange box. (We will not say a matchbox since an 80-piece orchestra coming therefrom would stretch the imagination too far.) Many audio engineers have examined the possibilities of small compromise horn-type enclosures since these may be capable of very impressive reproduction. The writer is not, however, addicted to impressive reproduction preferring to aim for accuracy. The horn cannot be compromised effectively and it can be stated categorically that good reproduction from, say, 50 c/s down to 30 c/s would demand an enormous horn. In any case it is questionable whether such high efficiency is necessary from a given loudspeaker unit. The labyrinth will

*Goodmans Industries Ltd.

SYMBOLS		
C_b = compliance of air in closed cabinet.	M_s = mass of air in slit.	R_v = viscous resistance of vent.
C_c = compliance of cone suspension.	M_v = mass of air in vent or orifice.	R_r = total resistance component of vent $\frac{6}{10} R_r = R_r$.
C_s = compliance of air between cone and front slit baffle.	$R_a = R_r(\pi r^2)^2$	v = velocity of cone.
$L_a = L_r(\pi r^2)^2$	R_c = resistance due to friction in cone.	Z_b = impedance due to loudspeaker mounting.
L_r = acoustic radiation mass.	R_d = mechanical resistance due to voice coil damping.	Z_r = acoustic radiation impedance.
M_c = mass of cone system.	R_r = radiation resistance.	$\omega = 2\pi f$.

C.g.s. units for mechanical and acoustical quantities, and e.m. units for electrical, have been assumed throughout.

secure the same downward extension of bass and freedom from resonance as a horn many times its size. Admittedly the amplifier is called upon to supply a few more low-frequency watts, but for normal requirements this is well within the capabilities of any of the well-known 10 or 15-W amplifiers. Even if an additional bass boost circuit has to be fitted, the cost and trouble is still hardly comparable to that of horn construction.

Space-saving considerations give the reflex enclosure a very great advantage over the other systems mentioned; in addition the acoustic characteristics are very good, and the principle suggests itself as being more amenable to compromise than that of the horn. A great deal of experimental work has been directed therefore to reducing still further the size of a reflex enclosure and improving its performance.

We saw in the previous article that, if its size is reduced, the reflex enclosure will present a higher impedance to the rear face of the cone at all frequencies, and, due to the increased impedance of a smaller port, the upper resonant frequency will become unduly prominent. We mentioned also that facing the cone into a restricted aperture or slit would reduce the resonance. This may now be explained by considering the analogous circuit (Fig. 8). Here the impedance due to the mass and resistance components of the slit appears as the series M_s and R_s shown. Now the lower resonant frequency

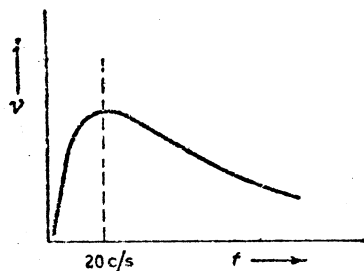

Fig. 9. General form of velocity/frequency response of cone required at very low frequencies.

will be substantially due to $R_c M_c C_c R_u M_s R_s M_v R_v$ in series and the upper resonant frequency due to $R_c M_c C_c R_u M_s R_s C_b$ in series. Since the impedance of M_s and R_s forms a greater proportion of the total mass reactance and resistance in the second case the upper resonance f_2 will be lowered both in frequency and amplitude to a greater extent than f_1 (see Fig. 11). A vertical slit also has the advantage of diffusing the higher frequencies horizontally due to its approaching a line source.

The condemning feature of the slit (or any other reduced orifice in front of the loudspeaker cone) is that in conjunction with the cavity (C_s) formed between the cone and the inside face of the material forming the slit, it constitutes a Helmholtz resonator, which makes itself heard very forcibly somewhere in the middle frequency (300 c/s-700 c/s) range. Standing waves also occur between the cone and the inside face, causing irregularities noticeable in the treble (1,000 c/s-5,000 c/s). We may, therefore, frown upon slits.

It is better to form the impedance M_s and R_s behind the cone by fitting, for example, a cowling† over the rear of the loudspeaker which has an outlet of restricted area, or, as is described in a patent held by Murphy Radio, a corrugated cardboard cylinder is fitted over the rear of the speaker, so that the

†Patent applied for by Goodmans Industries.

rear radiation must pass through the small tubes so formed.

These systems represent a very considerable improvement over the slit, although they still tend to introduce slight irregularities in the response. It is surprising, how efficiently even a cardboard drum can behave as a tubed pipe. Nevertheless it must be said the performance of these enclosures is very good for their size and at low frequencies is comparable to that of a full-sized labyrinth. Like the labyrinth they present a high resistive impedance to the rear of the loudspeaker cone; their efficiency is therefore low. It will be seen that M_s and R_s in the analogous circuit will tend to reduce the cone velocity at all frequencies. These components do therefore constitute a further loss of efficiency.

The reader should now be well acquainted with the principles involved in the design of the basic type of loudspeaker mounting and with the problems encountered, if these designs are comprised. The question of size is a very important one; there is a demand for a really high-quality sound-reproducing system that is small enough to be unobtrusive in a small lounge or flat.

A good approach to the design of such a system would be to state exactly what was meant by "really high quality" and to define the acoustic properties of the system in terms of cone velocity. This can be expressed as a function of mechanical impedance, which in turn may be translated into an analogous electrical impedance. The problem then resolves itself into the solving of the electrical circuitry. This approach led to the design of an enclosure having the desired performance and, proceeding as above, we shall endeavour to show the derivation of this design.

Enumerating the principal qualities of an "ideal" enclosure, we have:—

- (1) Frequency response extended down to at least 20 c/s.
- (2) Complete absence of resonances above this frequency.
- (3) Small size.
- (4) Efficiency as high as possible in keeping with (2) and (5).
- (5) Low distortion.

In order to satisfy requirements (1), (2) and (4) the cone velocity must increase progressively as the frequency is lowered to 20 c/s. Therefore, the enclosure must load the cone in such a way as to bring the effective cone resonance down to this frequency. There must be also a sufficiently high resistance component in order to satisfy requirement.

- (5) By limiting excessive increase of cone velocity due to resonant conditions.

In the analogy, these conditions are fulfilled by the velocity curve shown in Fig. 9, and the corresponding analogous circuit shown in Fig. 10, where inductive and resistive elements are added to the cone circuit.

As we have seen, a convenient way of adding mass to the loudspeaker cone is to load it by means of restricted orifice or vent. It is preferable to couple this air mass to the rear face of the cone, and since, at the resonance of the system (neglecting here any compliance existing between this air mass and the cone) the radiation from the vent will be in antiphase with that from the front of the cone, in order to produce negligible cancellation, the vent

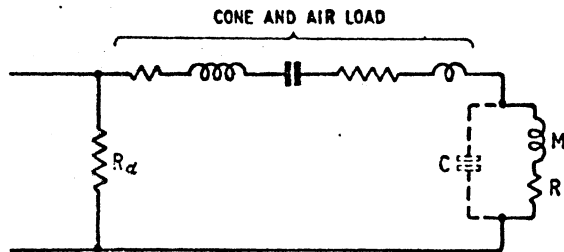

Fig. 10. Analogue circuit elements added to cone to produce response of Fig. 9.

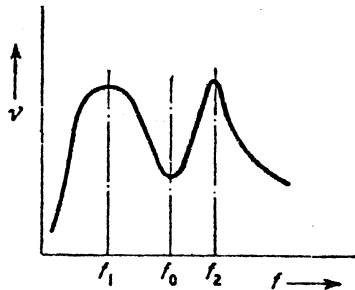

Fig. 11. Velocity/frequency response resulting from the addition of C in Fig. 10.

area must be considerably less than the effective piston area of the cone. Therefore, for a given mass reactance a small vent is preferable to a larger vent with a tunnel. As the orifice is reduced, however, the resistance due to viscosity at its edges is increased relatively to the mass reactance, and, whilst to some extent this is desirable for requirement (5) above, a point is reached where the rise in velocity down to the required frequency due to the action of the added mass is severely reduced, resulting in an undue loss of radiated power at these frequencies. This conflicts with requirement (4) above. These considerations therefore fix the port dimensions within fairly narrow limits, quite irrespective of whether the mass reactance from these dimensions is sufficient to reduce the loudspeaker cone resonance from wherever it is down to the required low-frequency limit. Since the mass reactance of the orifice will increase with frequency, it will be necessary to decouple this mass from the cone at the higher frequencies. This requires a shunt capacitance C in the analogy, which may be of such value, that in combination with the mass reactance ωM will produce an effective mass reactance $\omega M'$ having the value required to lower the effective resonance of the series circuit, i.e., the effective cone resonance by the desired amount. Since the capacitance C performs two functions, its value must be determined with both these in mind. For "decoupling" purposes the circuit must become capacitive as soon as possible above f_1 (Fig. 11) which indicates that the resonance of the parallel section f_0 should occur a little above this frequency. We shall see later, however, that it is desirable for f_0 to occur above the free-air resonant frequency of the loudspeaker cone. The effect of C on the effective cone resonance may be seen by considering the susceptance of the parallel section, which is:—

$$B = \frac{\omega^2 CM - 1}{\omega M}$$

and provided this expression is negative the circuit

will behave as an effective inductive reactance of magnitude

$$\omega M' = \frac{\omega M}{1 - \omega^2 CM}$$

To lower the effective cone resonance to a frequency f_1 the sum of the above expression, and the effective reactance of the cone must be zero at this frequency.

$$\text{Effective reactance of cone, } X'_{\text{cone}} = \frac{\omega^2 M_c C_c - 1}{\omega C_c}$$

By implication $\omega M'$ is positive at ω_1 and X'_{cone} negative at ω_1 .

$$\text{Equating we have } \frac{\omega^2 M_c C_c - 1}{\omega C_c} = \frac{\omega M}{1 + \omega^2 CM}$$

Transposing for C we have

$$C = \frac{C_c}{\omega^2 M_c C_c - 1} - \frac{1}{\omega^2 M}$$

Although a value of C may be found from this expression a lower limit is set to its value by its decoupling function. It is vital that the impedance of the parallel section be well decoupled at frequencies above about 50 c/s.

It is evident that the circuit we now have is analogous to a vented enclosure where the component values have been specially chosen to maintain the radiation efficiency down to 20 c/s. In the previous article we showed how a circuit of this type had three critical frequencies f_1 , f_0 and f_2 which resulted in a velocity curve as shown in Fig. 11. In the present case f_1 is our required low frequency resonance and in respect of our second requirement for the "ideal" enclosure the resonances at f_0 and f_2 must be eliminated. (f_0 in the present case is not coincident with the cone resonance.)

We have seen that the resonance at f_0 is due

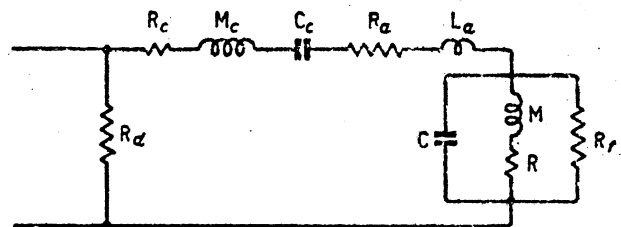

Fig. 12. Complete analogue of final design. R_i is an added acoustic resistance.

to the parallel section where its impedance rises to some high value reducing the cone velocity at this frequency. This impedance rise may, of course, be limited by shunting this circuit with a low resistance R_i , Fig. 12, the low limit of R_i being set by its damping effect at f_1 .

It has been found possible to choose values of M, C and R_i that are compatible with all the previous considerations and at the same time are such as to reduce the resonances at f_0 and f_2 to negligible proportions.

Let M and C have values producing a reactance characteristic which, relative to that of series components M_c and C_c will be as shown in Fig. 13. The three critical frequencies are shown, and it will be noticed that the reactance of the individual circuits at f_2 is much higher than at f_1 . If the effective reactance of M and C in parallel is X_p and this is shunted by R_i , then we may replace this

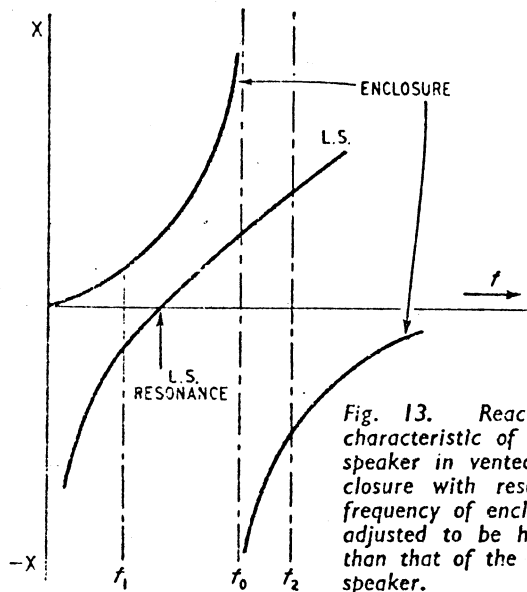

Fig. 13. Reactance characteristic of loudspeaker in vented enclosure with resonant frequency of enclosure adjusted to be higher than that of the loudspeaker.

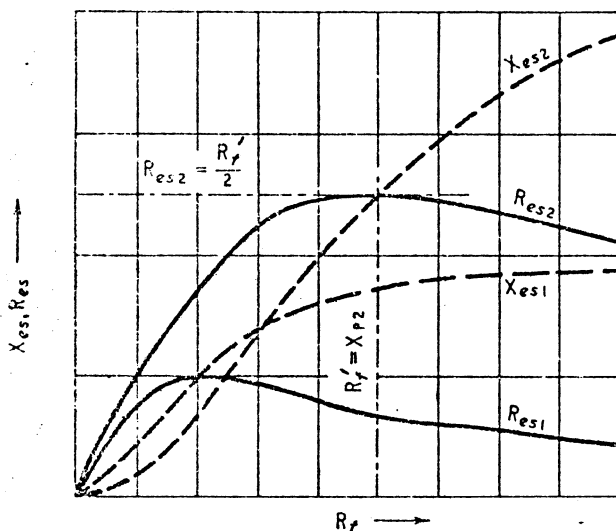

Fig. 14. Variation of X_{es} and R_{es} with R_f for two values of X_p when $X_{p1} < X_{p2}$.

arrangement by an equivalent series circuit consisting of a resistance R_{es} and reactance X_{es} which obey the well-known relationships:—

$$R_{es} = \frac{R_f X_p^2}{R_f^2 + X_p^2} \quad X_{es} = \frac{R_f^2 X_p^2}{R_f^2 + X_p^2}$$

The effect on R_{es} and X_{es} of varying R_f is shown in Fig. 14. The curves have been plotted for two values of X_p , i.e. X_{p1} and X_{p2} corresponding to those shown at f_1 and f_2 . It will be seen that the curve R_{es2} reaches a maximum at $R_f = X_{p2}^2$ where its value is $R_f/2$. At this point it will be seen that X_{es2} and R_{es2} are equal and the Q of the circuit under these conditions is therefore 1.

If we now consider a lower value of X_p corresponding to X_{p1} at f_1 we see from the curves that for the value $R_f = X_{p2}^2$ the Q clearly greater than 1. It is evident from the curves that R_f has a range of values that will produce higher damping at f_1 than at f_2 (and also some values that will produce the opposite effect). The action of the enclosure vector may be summarized by considering the locus of its impedance, which is part of a spiral

and is shown in Fig. 15. The presence of R_f will of course alter the actual values of the frequencies f_1 and f_2 , but again careful choice of component values enable us to hold f_1 at 20 c/s. We care not for the predicament of f_2 .

It was decided that the first prototype enclosure based on these principles should be designed for use in conjunction with the Goodmans Axiom 150 Mk. II loudspeaker. Accordingly the values of R_a , R_c , C_c , M_c and R_a in the analogy were determined from the physical constants of this loudspeaker and translated into acoustical terms. From this the dimensions of the enclosure and vent were determined, and an enclosure was constructed accordingly, the resistance being analogous to a resistive air leak in the enclosure walls. The impedance curves for this enclosure are compared in Fig. 16 with those of the reflex cabinet and a true infinite baffle when housing speakers identical to the above. The evidence is fairly conclusive. The effect of closing the air leak (removing R_f) is also shown.

There are a number of methods of forming the resistive air leak, all of them possessing varying degrees of manufacturing difficulty. One method is to make a number of very narrow slits in one or more of the enclosure walls. Another is to cover a relatively large aperture in an enclosure wall with a material of suitable porosity. In any event the resistance is due to the frictional component of the air leak and one of the principal practical difficulties has been to make this frictional component high relative to the mass component which is present in any aperture. In the analogous circuit this mass component appears as an inductance in series with R_f .

From the foregoing principles formulæ have been derived expressing the various cabinet dimen-

One of a range of acoustical resistance units designed to match Goodmans loudspeakers in cabinets of specified volume.

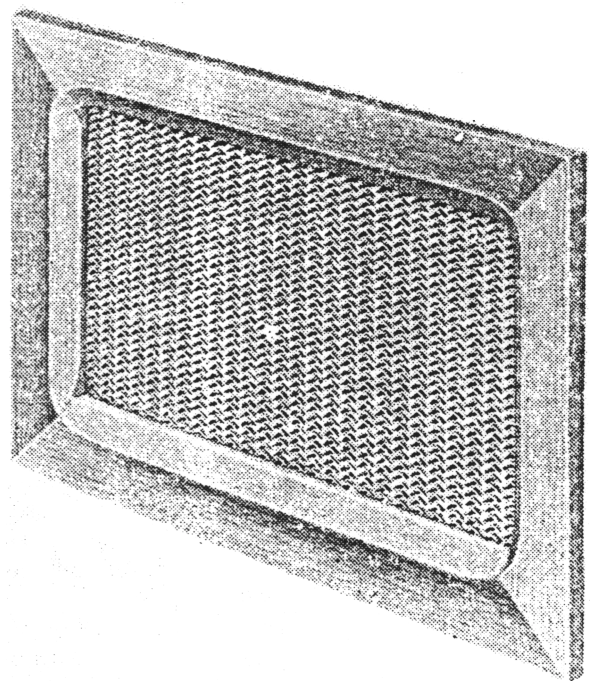

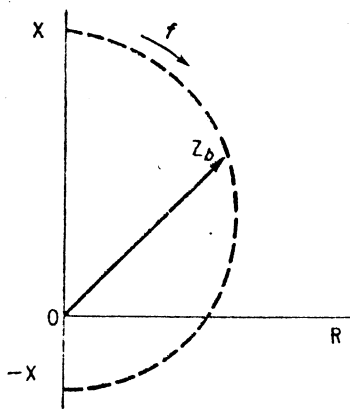

Left:—Fig. 15. Locus diagram showing variation with frequency of magnitude and direction of enclosure impedance vector.

Right:—Fig. 16. Voice-coil impedance curves of the Axiom 150 unit in the Axiom 172 enclosure and the same loudspeaker in various conventional mountings.

sions in terms of the loudspeaker constant and the desired frequency characteristics. The application of these formulæ, however, demands a complete knowledge of the conditions under which they were being used, otherwise the results can be laughable. In acoustics all sorts of nasty things happen; resistance varies with frequency (but only sometimes) and component values vary with the weather. One is almost tempted to suggest that guesswork would yield as good results.

Fortunately this is not quite true, and in order to simplify the design of enclosures for their various loudspeaker systems Goodmans Industries have worked out the optimum enclosure volume for each system and have designed and marketed for each system a panel containing the acoustic components corresponding to R_v and M in the foregoing analogies. These panels are slightly inaccurately known as acoustic resistance units or ARUs but in fact the required mass component is also included so that all the home constructor needs to do is to make a box of the prescribed internal volume and cut two holes, one for the loudspeaker and one for the appropriate ARU, and having lined the enclosure and screwed these items into place, the enclosure will exhibit all the properties originally stated. The manufacturers have produced this unit, since they feel that in view of the foregoing discussions it is not possible to offer any simple formulæ or design that could be used by persons not familiar with this type of work to produce the required acoustic components with any degree of accuracy.

The performance of Axiom enclosures has been compared with that of other types. Listening tests have shown that the bass radiation is somewhat better than that from the reflex type cabinet at middle bass frequencies and considerably better at the low frequencies, thereby imparting a warm, well-balanced quality to the reproduction. Tests with an oscillator showed that a strong, pure 20-c/s fundamental note could be radiated without excessive cone movement. Transient curves taken showed a very short decay time, characteristic of non-resonant conditions. This is the more interesting when one realizes that the volume of this type of enclosure is about half that of a correctly designed reflex cabinet for the same speaker.

In addition to the qualities mentioned this type of enclosure has the following advantages:—

- (1) It is simple and cheap to construct.
- (2) The dimensions of the enclosure (corresponding to C in the analogous circuit) are not extremely

- (1) AXIOM ENCLOSURE WITH TYPE 150 UNIT
- (2) REFLEX ENCLOSURE
- (3) INFINITE Baffle
- (4) AS (1) BUT WITH R_v OPEN CIRCUIT

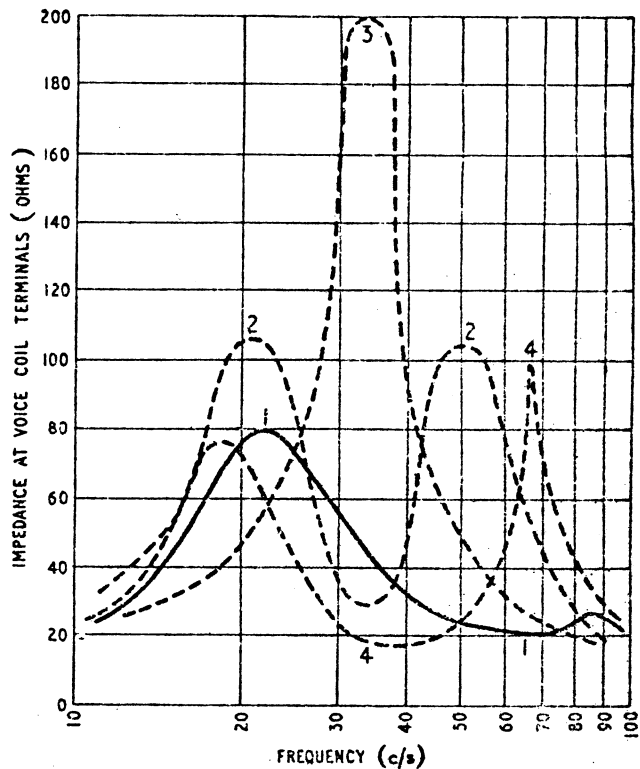

critical and may be varied up to $\pm 10\%$, if necessary for "styling."

(3) The enclosure can be of any shape and the acoustic resistance unit can be placed in any position relative to the speaker.

(4) The resonant frequency of the loudspeaker is not critical, although, if higher than the value for which the enclosure was designed, the bass extension will be reduced.

Theoretically the bass response of any enclosed loudspeaker will tend to fall, due to the damping applied to the cone reducing the condition of mass control. In the enclosure we have described, however, the impedance applied to the cone governs its velocity in a predetermined manner, thereby securing a higher efficiency, which in practice made bass boosting unnecessary, even when used in conjunction with loudspeakers having high electromagnetic damping.

This enclosure design has been named "Axiom" after the range of high-fidelity loudspeakers manufactured by Goodmans Industries. Patent applications have been made.